



# OR-DT42-4K22

UHD+ 4x2 HDMI Matrix with Dante Audio

**OPERATION MANUAL**

**HDMI<sup>®</sup>**  
HIGH-DEFINITION MULTIMEDIA INTERFACE

The terms HDMI, HDMI High-Definition Multimedia Interface, and the HDMI Logo are trademarks or registered trademarks of HDMI Licensing Administrator, Inc.

## **DISCLAIMERS**

The information in this manual has been carefully checked and is believed to be accurate. CYP (UK) Ltd assumes no responsibility for any infringements of patents or other rights of third parties which may result from its use.

CYP (UK) Ltd assumes no responsibility for any inaccuracies that may be contained in this document. CYP (UK) Ltd also makes no commitment to update or to keep current the information contained in this document.

CYP (UK) Ltd reserves the right to make improvements to this document and/or product at any time and without notice.

## **COPYRIGHT NOTICE**

No part of this document may be reproduced, transmitted, transcribed, stored in a retrieval system, or any of its part translated into any language or computer file, in any form or by any means—electronic, mechanical, magnetic, optical, chemical, manual, or otherwise—without express written permission and consent from CYP (UK) Ltd.

© Copyright 2022 by CYP (UK) Ltd.

All Rights Reserved.

Version 1.1

## **TRADEMARK ACKNOWLEDGMENTS**

All products or service names mentioned in this document may be trademarks of the companies with which they are associated.

---



## SAFETY PRECAUTIONS

Please read all instructions before attempting to unpack, install or operate this equipment and before connecting the power supply. Please keep the following in mind as you unpack and install this equipment:

- Always follow basic safety precautions to reduce the risk of fire, electrical shock and injury to persons.
- To prevent fire or shock hazard, do not expose the unit to rain, moisture or install this product near water.
- Never spill liquid of any kind on or into this product.
- Never push an object of any kind into this product through any openings or empty slots in the unit, as you may damage parts inside the unit.
- Do not attach the power supply cabling to building surfaces.
- Use only the supplied power supply unit (PSU). Do not use the PSU if it is damaged.
- Do not allow anything to rest on the power cabling or allow any weight to be placed upon it or any person walk on it.
- To protect the unit from overheating, do not block any vents or openings in the unit housing that provide ventilation and allow for sufficient space for air to circulate around the unit.
- Please completely disconnect the power when the unit is not in use to avoid wasting electricity.

## VERSION HISTORY

REV.	DATE	SUMMARY OF CHANGE
<b>RDV1</b>	2020/11/19	Preliminary release

# CONTENTS

<b>1. Introduction</b> .....	<b>1</b>
<b>2. Applications</b> .....	<b>1</b>
<b>3. Package Contents</b> .....	<b>1</b>
<b>4. System Requirements</b> .....	<b>2</b>
<b>5. Features</b> .....	<b>2</b>
<b>6. Operation Controls and Functions</b> .....	<b>3</b>
6.1 Front Panel .....	3
6.2 Rear Panel.....	4
6.3 RS-232 Pinout and Defaults .....	5
6.4 WebGUI Control .....	6
6.4.1 A/V Switch Tab.....	8
6.4.2 EDID Tab.....	10
6.4.3 Network Tab.....	12
6.4.4 System Tab .....	13
6.5 Telnet Control.....	15
6.6 Serial and Telnet Commands.....	15
<b>7. Connection Diagram</b> .....	<b>36</b>
<b>8. Specifications</b> .....	<b>37</b>
8.1 Technical Specifications .....	37
8.2 Video Specifications.....	38
8.3 Audio Specifications.....	40
8.3.1 Digital Audio .....	40
8.3.2 Analogue Audio .....	41
8.4 Cable Specifications .....	42
<b>9. Acronyms</b> .....	<b>43</b>

---

## 1. INTRODUCTION

This 4 by 2 HDMI Matrix with Dante Audio is a high performance HDMI switch which provides 4K UHD<sup>+</sup> (18Gbps) HDMI matrix routing and integrated Dante/AES67 network audio support, including insertion and extraction. It is an ideal solution for switching between multiple sources in a control room, conference room or classroom while simultaneously providing and receiving high quality digital stereo audio via the connected network. Video resolutions up to 4K@60Hz with 8 channel LPCM or HD bitstream audio is supported for local routing while 2 channel LPCM audio is supported via Dante.

Basic control of video and audio routing is provided by front panel controls, with additional control via WebGUI, RS-232, and Telnet. Dante audio management requires the use of 3rd party software, such as Dante Controller from Audinate.

## 2. APPLICATIONS

- /// Home Theaters
- /// Classrooms
- /// Lecture Halls

## 3. PACKAGE CONTENTS

- /// 1× UHD<sup>+</sup> 4×2 HDMI Matrix with Dante Audio
- /// 1× 5V/2.6A DC Power Adapter
- /// 2× 5-pin Terminal Block
- /// 1× 3-pin Terminal Block
- /// 1× Shockproof Feet (Set of 4)
- /// 1× Operation Manual

## 4. SYSTEM REQUIREMENTS

- /// HDMI source equipment such as media players, video game consoles, PCs, or set-top boxes.
- /// HDMI receiving equipment such as HDTVs, monitors or audio amplifiers.
- /// Analogue audio receiving equipment such as audio amplifiers or powered speakers.
- /// The use of Premium High Speed HDMI cables, and industry standard, Cat.6, Cat.6A or Cat.7, is highly recommended.
- /// 3rd party control software, such as Dante Controller from Audinate, is required to manage Dante audio routing to and from the unit.
- /// An active network connection from a Gigabit network switch or router with QoS support is highly recommended for Dante audio extension. Additional Dante networking details can be found here: <https://www.audinate.com/support/networks-and-switches>

## 5. FEATURES

- /// HDMI 2.0 and DVI 1.0 compliant (with the use of an HDMI-DVI adapter)
- /// HDCP 1.x and 2.2 compliant
- /// 4 HDMI inputs and 2 HDMI outputs
- /// 4x2 matrix routing with per-output analogue audio extraction
- /// Supports up to 4K UHD<sup>+</sup> (18Gbps, 4K@50/60Hz 4:4:4, 8-bit) video input and output
- /// Support pass-through of many audio formats including 8 channel LPCM, Bitstream, and HD Bitstream
- /// Each output's audio is selectable between the routed HDMI source or an independent Dante network audio source
- /// Compatible with existing Dante and AES67 audio networks for transmission and reception of uncompressed audio with near-zero latency
- /// Simple and easy network audio routing via 3rd party control software (available for both Windows and macOS systems)
- /// Per-input EDID management with internal or external EDID options
- /// Controllable via front panel buttons, WebGUI, Telnet, and RS-232

## 6. OPERATION CONTROLS AND FUNCTIONS

### 6.1 Front Panel

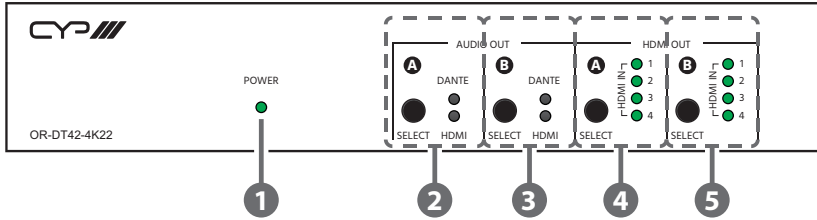

- 1 **POWER LED:** This LED will illuminate to indicate the unit is on and receiving power.
- 2 **AUDIO OUT A Button & LEDs:** Press this button to toggle the audio source, for HDMI and analogue audio output A, between the currently routed HDMI video's native audio or the currently routed Dante audio source.

*Note: The active Dante audio source for this output is set via 3rd party Dante control software.*

- 3 **AUDIO OUT B Button & LEDs:** Press this button to toggle the audio source, for HDMI and analogue audio output B, between the currently routed HDMI video's native audio or the currently routed Dante audio source.

*Note: The active Dante audio source for this output is set via 3rd party Dante control software.*

- 4 **HDMI OUT A Button and LEDs:** Press this button to sequentially switch through the available inputs to be routed to HDMI output A. The LED will illuminate to indicate which source is currently selected.
- 5 **HDMI OUT B Button and LEDs:** Press this button to sequentially switch through the available inputs to be routed to HDMI output B. The LED will illuminate to indicate which source is currently selected.



## 6.2 Rear Panel

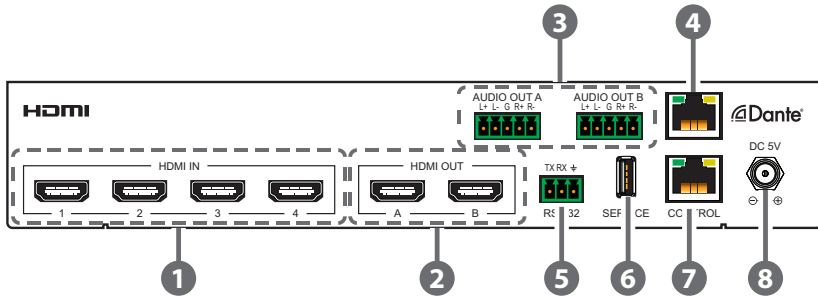

- 1 HDMI IN 1~4 Port:** Connect to HDMI source equipment such as media players, game consoles, or set-top boxes. DVI sources are supported with the use of an HDMI to DVI adapter.
- 2 HDMI OUT A~B Port:** Connect to HDMI TVs, monitors, or amplifiers for digital video and audio output.
- 3 AUDIO OUT 5-pin Terminal Blocks A~B:** Connect to powered speakers or an amplifier using 5-pin terminal blocks for balanced stereo analogue audio output.
- 4 DANTE Port:** Connect to a standard Ethernet network switch or router, which is hosting Dante audio transmitters or receivers, with a single Cat.5e/6/7 cable for transmission and routing of all available audio streams.
- 5 RS-232 3-pin Terminal Block:** Connect directly to a PC, laptop, or other serial control device with a 3-pin adapter cable to send RS-232 commands to control the unit.
- 6 SERVICE Port:** This port is reserved for firmware update use only.
- 7 CONTROL Port:** Connect directly, or through a network switch, to your PC/laptop to control the unit via Telnet/WebGUI.
- 8 DC 5V Port:** Plug the 5V DC power adapter into this port and connect it to an AC wall outlet for power.

### 6.3 RS-232 Pinout and Defaults

Serial Port Default Settings	
<b>Baud Rate</b>	19200
<b>Data Bits</b>	8
<b>Parity Bits</b>	None
<b>Stop Bits</b>	1
<b>Flow Control</b>	None

3-pin Terminal Block

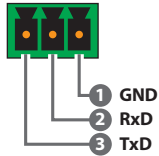

## 6.4 WebGUI Control

### /// Device Discovery

Please obtain the “Device Discovery” software from your authorised dealer and save it in a directory where you can easily find it.

Connect the unit and your PC/Laptop to the same active network and execute the “Device Discovery” software. Click on “Find Devices on Internet” and a list of devices connected to the local network will show up indicating their current IP address.

*Note: The unit's default IP address is 192.168.1.50.*

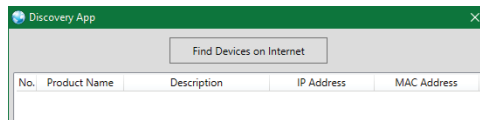

By clicking on one of the listed devices you will be presented with the network details of that particular device.

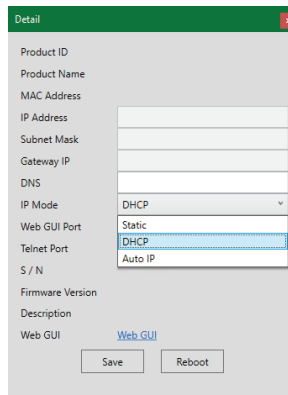

- 1) **IP Mode:** If you choose, you can alter the static IP network settings for the device, or switch the unit into DHCP mode to automatically obtain proper network settings from a local DHCP server. To switch to DHCP mode, please select DHCP from the IP mode drop-down, then click “Save” followed by “Reboot”.
- 2) **WebGUI Hotkey:** Once you are satisfied with the network settings, you may use them to connect via Telnet or WebGUI. The network information window provides a convenient link to launch the WebGUI directly.

### /// WebGUI Overview

After connecting to the WebGUI's address in a web browser, the login screen will appear. Please enter the appropriate user name and password then click "Submit" to log in.

*Note: The default user name and password is "admin".*

A login form with a blue "Login" button at the top left. Below it are two input fields: "Username" and "Password". At the bottom right is a "Submit" button.

On the left side of the browser you will see the following menu tabs where all primary functions of the unit are controllable via the built in WebGUI. The individual functions will be introduced in the following sections.

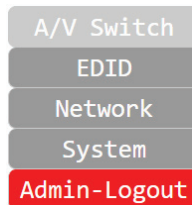

Clicking the red "Logout" tab will automatically log the currently connected user out of the WebGUI and return to login page.

### 6.4.1 A/V Switch Tab

This tab provides video routing control, audio routing control, analogue audio volume control and muting, HDCP management, and I/O renaming options. To assign a new video route, select one or both output buttons on the left and then click on the button of the preferred input source on the right. When a button is selected it will become highlighted. The new route will become active immediately and the routing information displayed on the output button will change accordingly.

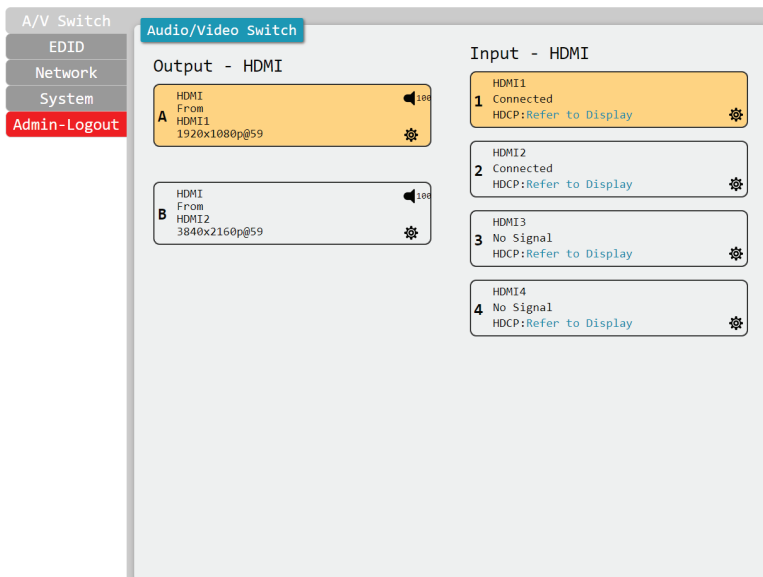

- 1) **Output:** These buttons display each output's name and details about the currently routed inputs. Clicking on the "Edit" icon (⚙️) opens up the Output Edit window. Clicking on the "Audio" icon (🔊) opens up the Audio Output Edit window.
- 2) **Input:** Buttons for selecting the input to route to an output. Details about each input's name and current sync/HDCP settings are also displayed here. Clicking on the "Edit" icon (⚙️) opens up the Input Edit window.
- 3) **Output Edit:** Provides control over the name of the output. To rename an output, type the new name in the space provided in the Edit window then click the "Save" button to confirm the change. The name can be up to 32 characters long.

- 4) **Audio Output Edit:** Provides control over audio source selection for the HDMI and analogue output and the volume level of the analogue audio output.

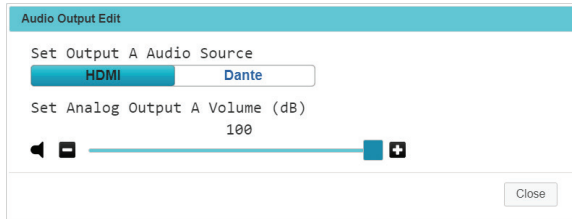

- **Set Output Audio Source:** Click on the button to toggle the audio output source between the native HDMI audio and the currently routed Dante audio.
  - **Set Analog Output Volume (dB):** Use the slider or +/- buttons to set the volume level of the analogue audio output. The available range is from 0 to 100.
- 5) **Input Edit:** Provides individual control over the name of each input as well as the behavior of HDCP on that input.

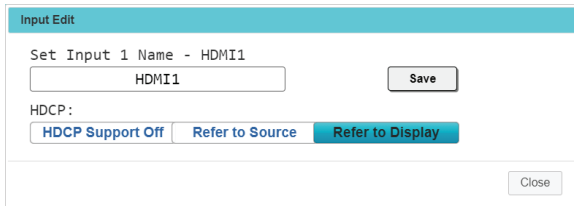

- **Set Input Name:** To rename an input, type the new name in the space provided in the edit window then click the “Save” button to confirm the change. The name can be up to 32 characters long.
- **HDCP:** Selects the HDCP logic to use with this HDMI input. Changes made to this setting occur immediately.
  - **HDCP Support Off:** Completely disables support for HDCP on this input.
  - **Refer to Source:** Makes the input port support the same HDCP version as required by the connected source.
  - **Refer to Display:** Makes the input support the HDCP version of the displays on the currently routed output(s).

## 6.4.2 EDID Tab

This tab provides control over the EDID settings for all inputs. This unit provides the option of six standard EDIDs, two sink sourced EDIDs and four user uploaded EDIDs that can be assigned to one input or all inputs as a group. The names of the user uploaded EDIDs can be changed if desired.

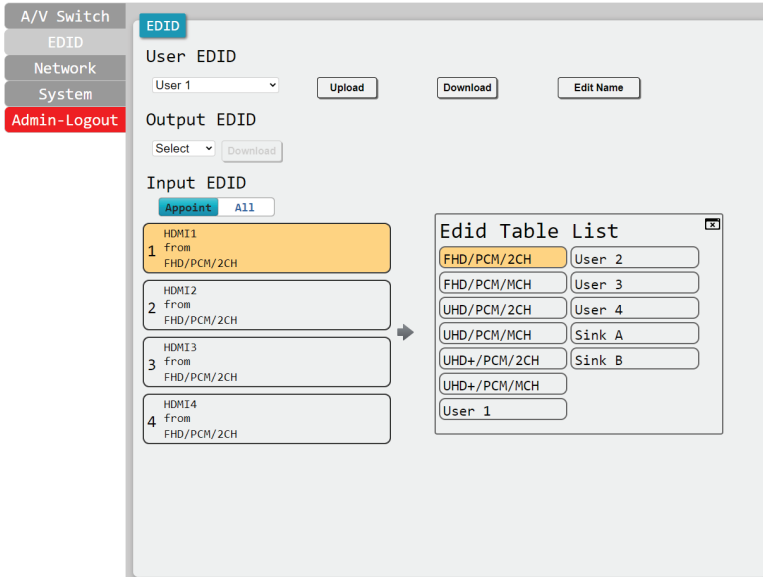

### 1) User EDID:

- **Upload:** To upload a User EDID, select the User EDID slot to upload into from the dropdown list and then click the “Upload” button. An EDID Upload window will appear, allowing you to locate and upload the preferred EDID file (\*.bin format) from a local PC. Once the correct file has been selected, please click the “Upload” button in the window, and the file will be transferred to the unit.
- **Download:** To save an existing User EDID to your local PC, select the User EDID slot from the dropdown list and then press the “Download” button. Depending on your browser settings you will either be asked where to save the downloaded file, or the file will be transferred to the default download location on your PC.
- **Edit Name:** Click the “Edit Name” button to open a window that allows changing the name of the User EDID. Click the “Save” button within the window to confirm the change.

## 2) Output EDID:

- **Download:** To save the EDID from a connected display to your local PC, select the sink from the dropdown list then press the “Download” button. Depending on your browser settings you will either be asked where to save the downloaded file, or the file will be transferred directly to the default download location on your PC.

## 3) Input EDID: This section provides controls for assigning a new EDID to one, or all inputs within the system.

- **Appoint/All:** Selecting “All” will allow the assignment of a single EDID to all inputs simultaneously. Selecting “Appoint” allows for a different EDID to be assigned to each HDMI input.
- **EDID Selection:** Click on one or more input buttons to open the EDID Table List window. Select the new EDID source to use, from the choices on the right, and the change will occur immediately across all selected Inputs.

This unit provides the following 6 default EDIDs:

Unit's default EDIDs	
<b>FHD/PCM/2CH</b>	1920×1080p@60Hz (4.95Gbps) & 8-bit colour, LPCM 2.0
<b>FHD/PCM/MCH</b>	1920×1080p@60Hz (4.95Gbps) & 8-bit colour, LPCM 7.1
<b>UHD/PCM/2CH</b>	3840×2160p@30Hz (10.2Gbps) & Deep Colour (8/10/12-bit), LPCM 2.0
<b>UHD/PCM/MCH</b>	3840×2160p@30Hz (10.2Gbps) & Deep Colour (8/10/12-bit), LPCM 7.1
<b>UHD<sup>+</sup>/PCM/2CH</b>	3840×2160p@60Hz (18Gbps) & Deep Colour (8/10/12-bit), LPCM 2.0
<b>UHD<sup>+</sup>/PCM/MCH</b>	3840×2160p@60Hz (18Gbps) & Deep Colour (8/10/12-bit), LPCM 7.1

*Note: In some rare cases it is possible for custom or external EDIDs to cause compatibility issues with certain sources. If this happens, it is recommended to switch to one of the 6 default EDIDs for maximum compatibility.*



### 6.4.3 Network Tab

This tab provides network configuration options including changing the IP mode, viewing/setting the IP configuration, changing the admin login password, and changing the Web Login timeout.

*Note: The default IP address is 192.168.1.50.*

- 1) IP Configuration:** IP Mode may be switched between Static IP or DHCP. In Static IP Mode the IP, netmask and gateway addresses must be manually set. When in DHCP Mode, the unit will attempt to connect to a local DHCP server and obtain IP, netmask and gateway addresses automatically. Please press "Save" after making any changes to the IP configuration or mode.

*Note: If the IP address is changed then the IP address required for WebGUI/Telnet access will also change accordingly.*

- 2) Web Login Account:** The WebGUI admin password can be changed here. Please press "Save" after entering the old and new passwords to enact the change.

*Note: The default password is "admin."*

- 3) Web Login Timeout:** Select the length of time to wait before logging the user out of the WebGUI due to inactivity. The available range is from 0 to 240 minutes. Setting it to 0 will disable the timeout function.

## 6.4.4 System Tab

This tab provides system configuration backup/restore options, controls to perform a factory reset or system reboot, firmware update support, controls to change the unit's Dante device name, and shows the unit's serial number.

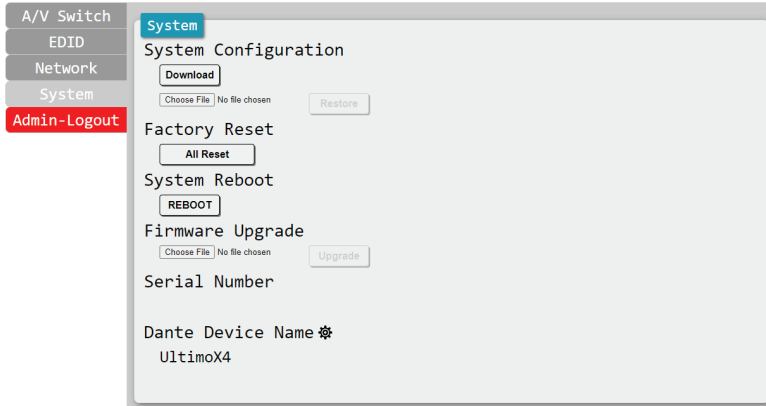

### 1) System Configuration:

- **Download:** The current system configuration, including routing and settings, may be saved as an XML file to a PC. Click the “Download” button to save the current system configuration to your local PC.
- **Restore:** Previously saved system configurations may be restored from a saved XML file. Click the “Choose File” button to locate the saved XML file, then click the “Restore” button to upload and activate the selected configuration.

2) **Factory Reset:** Press the “All Reset” button to reset the unit to its factory default state. After the reset is complete, the unit will reboot automatically.

3) **System Reboot:** Click this button to reboot the unit.

4) **Firmware Upgrade:** To update the unit’s firmware, click the “Choose File” button to open the file selection window and then select the firmware update file (\*.bin format) located on your local PC. After selecting the file, click the “Upgrade” button to begin the firmware update process. After the upgrade is complete, the unit will reboot automatically.

- 5) **Serial Number:** Displays the unit's serial number.
- 6) **Dante Device Name:** Displays the unit's current Dante device name. Clicking on the "Edit" icon () opens up the Dante Device Name Edit window.
- 7) **Dante Device Name Edit:** To change the unit's name, type the new name in the space provided then click the "Save" button to confirm the change. The name can be up to 31 characters long.

*Note: Dante device names must consist of standard alpha-numeric characters, and cannot contain space or underscore "\_" characters. The hyphen character "-" can be used, but not at the beginning or end of the name.*

## 6.5 Telnet Control

Before attempting to use Telnet control, please ensure that both the unit and the PC are connected to the same active networks.

Start your preferred Telnet/Console client, or use the built in client provided by most modern computer operating systems. After starting the client, connect by using the current IP address of the unit and port 23 (if the communication port number used by the unit has not been changed previously). This will connect us to the unit we wish to control and commands may now be entered directly.

*Note 1: If the IP address of the unit is changed then the IP address required for Telnet access will also change accordingly.*

*Note 2: The default IP address is 192.168.1.50 and the default communication port is 23.*

## 6.6 Serial and Telnet Commands

COMMAND
Description and Parameters
<b>help</b> ← Show the full command list.
<b>help N1</b> ← Show details about the specified command. <b>N1</b> = {Command}
<b>?</b> ← Show the full command list.
<b>? N1</b> ← Show details about the specified command. <b>N1</b> = {Command}
<b>get fw ver</b> ← Show the unit's current firmware version.

COMMAND																	
Description and Parameters																	
<b>get command ver</b> ↵↵	Show the unit's current command version.																
<b>get mac addr</b> ↵↵	Show the unit's MAC address.																
<b>get model name</b> ↵↵	Show the unit's model name.																
<b>get model type</b> ↵↵	Show the unit's product type. Possible response values: <table border="0"> <tr><td>1</td><td>[Matrix]</td></tr> <tr><td>2</td><td>[Scaler]</td></tr> <tr><td>3</td><td>[Splitter]</td></tr> <tr><td>4</td><td>[Repeater]</td></tr> <tr><td>5</td><td>[Extender]</td></tr> <tr><td>6</td><td>[Transceiver]</td></tr> <tr><td>7</td><td>[Switch]</td></tr> <tr><td>8</td><td>[Controller]</td></tr> </table>	1	[Matrix]	2	[Scaler]	3	[Splitter]	4	[Repeater]	5	[Extender]	6	[Transceiver]	7	[Switch]	8	[Controller]
1	[Matrix]																
2	[Scaler]																
3	[Splitter]																
4	[Repeater]																
5	[Extender]																
6	[Transceiver]																
7	[Switch]																
8	[Controller]																
<b>set factory default</b> ↵↵	Reset all settings to the factory defaults.																
<b>set factory ipconfig default</b> ↵↵	Reset the unit's network settings to the factory defaults																
<b>set factory out route default</b> ↵↵	Reset the unit's routing to the factory defaults																
<b>get user config</b> ↵↵	List the unit's current configuration information.																

COMMAND				
Description and Parameters				
<p><b>set feedback broadcast N1</b> ←</p> <p>Enable or disable the broadcast of console command feedback.</p> <p>Available values for <b>N1</b>:</p> <table style="width: 100%; border: none;"> <tr> <td style="width: 50%;">ON</td> <td>[Enable]</td> </tr> <tr> <td>OFF</td> <td>[Disable]</td> </tr> </table>	ON	[Enable]	OFF	[Disable]
ON	[Enable]			
OFF	[Disable]			
<p><b>get feedback broadcast</b> ←</p> <p>Show the current console command feedback broadcast state.</p>				
<p><b>set local echo N1</b> ←</p> <p>Enable or disable the local echo display of typed characters for RS-232 connections.</p> <p>Available values for <b>N1</b>:</p> <table style="width: 100%; border: none;"> <tr> <td style="width: 50%;">ON</td> <td>[Enable]</td> </tr> <tr> <td>OFF</td> <td>[Disable]</td> </tr> </table>	ON	[Enable]	OFF	[Disable]
ON	[Enable]			
OFF	[Disable]			
<p><b>get local echo</b> ←</p> <p>Show the current local echo display setting.</p>				
<p><b>set system reboot</b> ←</p> <p>Reboot the unit.</p>				
<p><b>set keylock N1</b> ←</p> <p>Enable or disable the front panel key lock.</p> <p>Available values for <b>N1</b>:</p> <table style="width: 100%; border: none;"> <tr> <td style="width: 50%;">ON</td> <td>[Locked]</td> </tr> <tr> <td>OFF</td> <td>[Unlocked]</td> </tr> </table>	ON	[Locked]	OFF	[Unlocked]
ON	[Locked]			
OFF	[Unlocked]			
<p><b>get keylock</b> ←</p> <p>Show the current front panel lock state.</p>				
<p><b>set uart 1 reset</b> ←</p> <p>Reset the unit's RS-232 settings to the factory defaults.</p>				

**COMMAND****Description and Parameters****set uart 1 baudrate N1 ↵**

Set the baud rate of the RS-232 port.

Available values for **N1**:

4800	[4800 baud]
9600	[9600 baud]
19200	[19200 baud]
38400	[38400 baud]
57600	[57600 baud]
115200	[115200 baud]

**get uart 1 baudrate ↵**

Show the current baud rate of the RS-232 port.

**set uart 1 stop bit N1 ↵**

Set the number of stop bits for the RS-232 port.

Available values for **N1**:

1	[1 Stop Bit]
2	[2 Stop Bits]

**get uart 1 stop bit ↵**

Show the current number of stop bits of the RS-232 port.

**set uart 1 data bit N1 ↵**

Set the data bits for the RS-232 port.

Available values for **N1**:

5	[5 data bits]
6	[6 data bits]
7	[7 data bits]
8	[8 data bits]

**get uart 1 data bit ↵**

Show the current number of data bits of the RS-232 port.

COMMAND							
Description and Parameters							
<b>set uart 1 parity N1</b> ↵	<p>Set the parity of the RS-232 port.</p> <p>Available values for <b>N1</b>:</p> <table> <tr> <td>0</td> <td>[None]</td> </tr> <tr> <td>1</td> <td>[Odd]</td> </tr> <tr> <td>2</td> <td>[Even]</td> </tr> </table>	0	[None]	1	[Odd]	2	[Even]
0	[None]						
1	[Odd]						
2	[Even]						
<b>get uart 1 parity</b> ↵	<p>Show the current parity setting of the RS-232 port.</p>						
<b>set ip mode N1</b> ↵	<p>Set the unit's IP address assignment mode.</p> <p>Available values for <b>N1</b>:</p> <table> <tr> <td>STATIC</td> <td>[Static IP mode]</td> </tr> <tr> <td>DHCP</td> <td>[DHCP mode]</td> </tr> </table>	STATIC	[Static IP mode]	DHCP	[DHCP mode]		
STATIC	[Static IP mode]						
DHCP	[DHCP mode]						
<b>get ip mode</b> ↵	<p>Show the current IP address assignment mode.</p>						
<b>get ipconfig</b> ↵	<p>Show the unit's current IP configuration information</p>						
<b>get ip addr</b> ↵	<p>Show the unit's current IP address.</p>						
<b>get netmask</b> ↵	<p>Show the unit's current netmask.</p>						
<b>get gateway</b> ↵	<p>Show the unit's current gateway address.</p>						



COMMAND	
Description and Parameters	
<b>set static ipaddr N1</b> ←	
Set the unit's static IP address.	
<b>N1 = X.X.X.X</b>	[X = 0~255, IP address]
<b>get static ipaddr</b> ←	
Show the unit's current static IP address.	
<b>set static netmask N1</b> ←	
Set the unit's static netmask.	
<b>N1 = X.X.X.X</b>	[X = 0~255, Netmask]
<b>get static netmask</b> ←	
Show the unit's current static netmask.	
<b>set static gateway N1</b> ←	
Set the unit's static gateway address.	
<b>N1 = X.X.X.X</b>	[X = 0~255, Gateway address]
<b>get static gateway</b> ←	
Show the unit's current static gateway address.	
<b>get webgui username</b> ←	
Show the WebGUI login username.	
<i>Note: Only available via RS-232.</i>	
<b>set webgui password N1</b> ←	
Set the WebGUI administrator password.	
<b>N1 = {Password}</b>	[ASCII, 32 characters max]
<i>Note: Only available via RS-232.</i>	

COMMAND
Description and Parameters
<p><b>get webgui password</b> ←</p> <p>Show the current WebGUI administrator password.</p> <p><i>Note: Only available via RS-232.</i></p>
<p><b>set telnet username N1</b> ←</p> <p>Set the Telnet login username.</p> <p><b>N1</b> = {Name}            [ASCII, 32 characters max]</p> <p><i>Note: Only available via RS-232.</i></p>
<p><b>get telnet username</b> ←</p> <p>Show the current Telnet login username.</p> <p><i>Note: Only available via RS-232.</i></p>
<p><b>set telnet password N1</b> ←</p> <p>Set the Telnet login password.</p> <p><b>N1</b> = {Password}        [ASCII, 32 characters max]</p> <p><i>Note: Only available via RS-232.</i></p>
<p><b>get telnet password</b> ←</p> <p>Show the current Telnet login password.</p> <p><i>Note: Only available via RS-232.</i></p>
<p><b>set telnet login N1</b> ←</p> <p>Enable or disable requiring a login for Telnet connections.</p> <p>Available values for <b>N1</b>:</p> <p>ON                            [Login is required]</p> <p>OFF                            [Login is not required]</p> <p><i>Note: Only available via RS-232.</i></p>

COMMAND									
Description and Parameters									
<b>get telnet login</b> ←	<p>Show the current state of the Telnet login requirement.</p> <p><i>Note: Only available via RS-232.</i></p>								
<b>set webgui login timeout N1</b> ←	<p>Set the WebGUI inactivity timeout value.</p> <p>Available values for <b>N1</b>:</p> <table> <tr> <td>0</td> <td>[No timeout]</td> </tr> <tr> <td>1~240</td> <td>[Timeout in minutes]</td> </tr> </table>	0	[No timeout]	1~240	[Timeout in minutes]				
0	[No timeout]								
1~240	[Timeout in minutes]								
<b>get webgui login timeout</b> ←	<p>Show the current WebGUI inactivity timeout value.</p>								
<b>set in N1 name N2</b> ←	<p>Set the name of the specified input.</p> <p>Available values for <b>N1</b>:</p> <table> <tr> <td>1</td> <td>[HDMI input 1]</td> </tr> <tr> <td>2</td> <td>[HDMI input 2]</td> </tr> <tr> <td>3</td> <td>[HDMI input 3]</td> </tr> <tr> <td>4</td> <td>[HDMI input 4]</td> </tr> </table> <p><b>N2</b> = {Name}      [ASCII, 32 characters max]</p>	1	[HDMI input 1]	2	[HDMI input 2]	3	[HDMI input 3]	4	[HDMI input 4]
1	[HDMI input 1]								
2	[HDMI input 2]								
3	[HDMI input 3]								
4	[HDMI input 4]								
<b>get in N1 name</b> ←	<p>Show the current name of the specified input.</p> <p>Available values for <b>N1</b>:</p> <table> <tr> <td>1</td> <td>[HDMI input 1]</td> </tr> <tr> <td>2</td> <td>[HDMI input 2]</td> </tr> <tr> <td>3</td> <td>[HDMI input 3]</td> </tr> <tr> <td>4</td> <td>[HDMI input 4]</td> </tr> </table>	1	[HDMI input 1]	2	[HDMI input 2]	3	[HDMI input 3]	4	[HDMI input 4]
1	[HDMI input 1]								
2	[HDMI input 2]								
3	[HDMI input 3]								
4	[HDMI input 4]								

COMMAND												
Description and Parameters												
<p><b>set out N1 name N2</b>↵</p> <p>Set the name of the specified output.</p> <p>Available values for <b>N1</b>:</p> <table> <tr> <td>A</td> <td>[HDMI output A]</td> </tr> <tr> <td>B</td> <td>[HDMI output B]</td> </tr> </table> <p><b>N2</b> = {Name}            [ASCII, 32 characters max]</p>	A	[HDMI output A]	B	[HDMI output B]								
A	[HDMI output A]											
B	[HDMI output B]											
<p><b>get out N1 name</b>↵</p> <p>Show the name of the specified output.</p> <p>Available values for <b>N1</b>:</p> <table> <tr> <td>A</td> <td>[HDMI output A]</td> </tr> <tr> <td>B</td> <td>[HDMI output B]</td> </tr> </table>	A	[HDMI output A]	B	[HDMI output B]								
A	[HDMI output A]											
B	[HDMI output B]											
<p><b>set out N1 route N2</b>↵</p> <p>Route the specified input to the specified output.</p> <p>Available values for <b>N1</b>:</p> <table> <tr> <td>A</td> <td>[HDMI output A]</td> </tr> <tr> <td>B</td> <td>[HDMI output B]</td> </tr> </table> <p>Available values for <b>N2</b>:</p> <table> <tr> <td>1</td> <td>[HDMI input 1]</td> </tr> <tr> <td>2</td> <td>[HDMI input 2]</td> </tr> <tr> <td>3</td> <td>[HDMI input 3]</td> </tr> <tr> <td>4</td> <td>[HDMI input 4]</td> </tr> </table>	A	[HDMI output A]	B	[HDMI output B]	1	[HDMI input 1]	2	[HDMI input 2]	3	[HDMI input 3]	4	[HDMI input 4]
A	[HDMI output A]											
B	[HDMI output B]											
1	[HDMI input 1]											
2	[HDMI input 2]											
3	[HDMI input 3]											
4	[HDMI input 4]											
<p><b>get out N1 route</b>↵</p> <p>Show the current input routed to the specified output.</p> <p>Available values for <b>N1</b>:</p> <table> <tr> <td>A</td> <td>[HDMI output A]</td> </tr> <tr> <td>B</td> <td>[HDMI output B]</td> </tr> </table>	A	[HDMI output A]	B	[HDMI output B]								
A	[HDMI output A]											
B	[HDMI output B]											

**COMMAND****Description and Parameters****get in N1 hactive**↵

Show the horizontal active pixel value of the specified input's current video source.

Available values for **N1**:

- |   |                |
|---|----------------|
| 1 | [HDMI input 1] |
| 2 | [HDMI input 2] |
| 3 | [HDMI input 3] |
| 4 | [HDMI input 4] |

**get in N1 vactive**↵

Show the vertical active pixel value of the specified input's current video source.

Available values for **N1**:

- |   |                |
|---|----------------|
| 1 | [HDMI input 1] |
| 2 | [HDMI input 2] |
| 3 | [HDMI input 3] |
| 4 | [HDMI input 4] |

**get in N1 refresh rate**↵

Show the refresh rate of the specified input's current video source.

Available values for **N1**:

- |   |                |
|---|----------------|
| 1 | [HDMI input 1] |
| 2 | [HDMI input 2] |
| 3 | [HDMI input 3] |
| 4 | [HDMI input 4] |

## COMMAND

### Description and Parameters

#### **get in N1 interlace**←

Show the interlace state of the specified input's current video source.

Available values for **N1**:

1	[HDMI input 1]
2	[HDMI input 2]
3	[HDMI input 3]
4	[HDMI input 4]

Possible response values:

0	[Progressive]
1	[Interlaced]

#### **get in N1 sync status**←

Show the current sync state of the specified input.

Available values for **N1**:

1	[HDMI input 1]
2	[HDMI input 2]
3	[HDMI input 3]
4	[HDMI input 4]

Possible response values:

0	[No sync]
1	[Sync active]

#### **get out N1 sync status**←

Show the current sync state of the specified output.

Available values for **N1**:

A	[HDMI output A]
B	[HDMI output B]

Possible response values:

0	[No sync]
1	[Sync active]

**COMMAND****Description and Parameters****set in N1 hdcp mode N2**↵

Set the HDCP behavior of the specified input.

Available values for **N1**:

1	[HDMI input 1]
2	[HDMI input 2]
3	[HDMI input 3]
4	[HDMI input 4]

Available values for **N2**:

0	[HDCP support off]
1	[Refer to source]
2	[Refer to display]

**get in N1 hdcp mode**↵

Show the current HDCP behavior used by the specified input.

Available values for **N1**:

1	[HDMI input 1]
2	[HDMI input 2]
3	[HDMI input 3]
4	[HDMI input 4]

**get in N1 hdcp status**↵

Show the current HDCP status of the specified input.

Available values for **N1**:

1	[HDMI input 1]
2	[HDMI input 2]
3	[HDMI input 3]
4	[HDMI input 4]

Possible response values:

0	[No HDCP]
1	[HDCP 1.x]
2	[HDCP 2.2]

## COMMAND

### Description and Parameters

#### get out N1 hdcp status↵

Show the current HDCP status of the specified output.

Available values for **N1**:

A	[HDMI output A]
B	[HDMI output B]

Possible response values:

0	[No HDCP]
1	[HDCP 1.x]
2	[HDCP 2.2]
3	[HDCP 1.x failed]
4	[HDCP 2.x failed]

#### set in N1 edid N2↵

Set the EDID to use on the specified input.

Available values for **N1**:

1	[HDMI Input 1]
2	[HDMI input 2]
3	[HDMI Input 3]
4	[HDMI Input 4]

Available values for **N2**:

1	[FHD 2CH]
2	[FHD MCH]
3	[UHD 2CH]
4	[UHD MCH]
5	[UHD <sup>+</sup> 2CH]
6	[UHD <sup>+</sup> MCH]
7	[User EDID 1]
8	[User EDID 2]
9	[User EDID 3]
10	[User EDID 4]
11	[Sink A EDID]
12	[Sink B EDID]



## COMMAND

### Description and Parameters

#### **get in N1 edid**↵

Show the EDID currently being used on the specified input.

Available values for **N1**:

1	[HDMI Input 1]
2	[HDMI input 2]
3	[HDMI Input 3]
4	[HDMI Input 4]

#### **set edid N1 name N2**↵

Set the name for the specified EDID. (Only User EDIDs may be renamed)

Available values for **N1**:

7	[User EDID 1]
8	[User EDID 2]
9	[User EDID 3]
10	[User EDID 4]

**N2** = {Name} [ASCII, 32 characters max]

#### **get edid N1 name**↵

Show the current name for the specified EDID.

Available values for **N1**:

1	[FHD 2CH]
2	[FHD MCH]
3	[UHD 2CH]
4	[UHD MCH]
5	[UHD <sup>+</sup> 2CH]
6	[UHD <sup>+</sup> MCH]
7	[User EDID 1]
8	[User EDID 2]
9	[User EDID 3]
10	[User EDID 4]
11	[Sink A EDID]
12	[Sink B EDID]

COMMAND	
Description and Parameters	
<b>set user N1 edid data N2</b> ↵	
Upload a new EDID (in hex format) for use as the specified User EDID.	
Available values for <b>N1</b> :	
1	[User EDID 1]
2	[User EDID 2]
3	[User EDID 3]
4	[User EDID 4]
<b>N2</b> = {EDID data}	[Comma delimited hex pairs]
<b>get user N1 edid data</b> ↵	
Show the current contents of the specified User EDID as hex data.	
Available values for <b>N1</b> :	
1	[User EDID 1]
2	[User EDID 2]
3	[User EDID 3]
4	[User EDID 4]
<b>get sink N1 edid data</b> ↵	
Show the EDID from the display connected to the specified output as hex data.	
Available values for <b>N1</b> :	
A	[HDMI output A]
B	[HDMI output B]

**COMMAND****Description and Parameters****get in N1 edid data** ←

Show the EDID currently used by the specified input as hex data.

Available values for **N1**:

- |   |                |
|---|----------------|
| 1 | [HDMI Input 1] |
| 2 | [HDMI input 2] |
| 3 | [HDMI Input 3] |
| 4 | [HDMI Input 4] |

**get all in edid list** ←

List the EDIDs assigned to all inputs.

**get internal N1 edid data** ←

Show the specified internal EDID as hex data.

Available values for **N1**:

- |   |            |
|---|------------|
| 1 | [FHD 2CH]  |
| 2 | [FHD MCH]  |
| 3 | [UHD 2CH]  |
| 4 | [UHD MCH]  |
| 5 | [UHD+ 2CH] |
| 6 | [UHD+ MCH] |

**set all in edid mode N1** ←

Select the EDID management mode to use (All or Appoint) for all inputs.

Available values for **N1**:

- |     |           |
|-----|-----------|
| ON  | [All]     |
| OFF | [Appoint] |

**get all in edid mode** ←

Show the current EDID management mode used by all inputs.

## COMMAND

### Description and Parameters

#### **set all in edid N1** ←

Set the EDID to use when the “All” EDID mode is active.

Available values for **N1**:

1	[FHD 2CH]
2	[FHD MCH]
3	[UHD 2CH]
4	[UHD MCH]
5	[UHD <sup>+</sup> 2CH]
6	[UHD <sup>+</sup> MCH]
7	[User EDID 1]
8	[User EDID 2]
9	[User EDID 3]
10	[User EDID 4]
11	[Sink A EDID]
12	[Sink B EDID]

#### **get all in edid** ←

Show the current EDID used by the “All” EDID mode.

#### **set audio out N1 mute N2** ←

Enable or disable muting the specified audio output.

Available values for **N1**:

A	[Analogue audio output A]
B	[Analogue audio output B]

Available values for **N2**:

ON	[Mute]
OFF	[Unmute]

#### **get audio out N1 mute** ←

Show the current mute state of the specified output.

Available values for **N1**:

A	[Analogue audio output A]
B	[Analogue audio output B]

**COMMAND****Description and Parameters****set audio out all mute N1** ←

Enable or disable muting on all analogue audio outputs.

Available values for **N1**:

ON	[Mute]
OFF	[Unmute]

**set audio out N1 route N2** ←

Set the audio routing source for the specified audio output.

Available values for **N1**:

A	[HDMI/analogue audio output A]
B	[HDMI/analogue audio output B]

Available values for **N2**:

1	[HDMI audio]
2	[Dante Audio]

**get audio out N1 route** ←

Show the current audio routing for the specified audio output.

Available values for **N1**:

A	[HDMI/analogue audio output A]
B	[HDMI/analogue audio output B]

**set audio out N1 volume N2** ←

Set the volume level of the specified output's audio.

Available values for **N1**:

A	[Analogue audio output A]
B	[Analogue audio output B]

**N2** = 0~100 [Audio volume level in dB]

COMMAND				
Description and Parameters				
<p><b>get audio out N1 volume</b>↵</p> <p>Show the current volume level of the specified output's audio.</p> <p>Available values for <b>N1</b>:</p> <table> <tr> <td>A</td> <td>[Analogue audio output A]</td> </tr> <tr> <td>B</td> <td>[Analogue audio output B]</td> </tr> </table>	A	[Analogue audio output A]	B	[Analogue audio output B]
A	[Analogue audio output A]			
B	[Analogue audio output B]			
<p><b>set audio out N1 volume up</b>↵</p> <p>Increase the volume level of the specified output's audio by 1 unit.</p> <p>Available values for <b>N1</b>:</p> <table> <tr> <td>A</td> <td>[Analogue audio output A]</td> </tr> <tr> <td>B</td> <td>[Analogue audio output B]</td> </tr> </table>	A	[Analogue audio output A]	B	[Analogue audio output B]
A	[Analogue audio output A]			
B	[Analogue audio output B]			
<p><b>set audio out N1 volume down</b>↵</p> <p>Decrease the volume level of the specified output's audio by 1 unit.</p> <p>Available values for <b>N1</b>:</p> <table> <tr> <td>A</td> <td>[Analogue audio output A]</td> </tr> <tr> <td>B</td> <td>[Analogue audio output B]</td> </tr> </table>	A	[Analogue audio output A]	B	[Analogue audio output B]
A	[Analogue audio output A]			
B	[Analogue audio output B]			
<p><b>set audio out N1 name N2</b>↵</p> <p>Set the name for the specified output's audio.</p> <p>Available values for <b>N1</b>:</p> <table> <tr> <td>A</td> <td>[Audio output A]</td> </tr> <tr> <td>B</td> <td>[Audio output B]</td> </tr> </table> <p><b>N2</b> = {Name} [ASCII, 32 characters max]</p>	A	[Audio output A]	B	[Audio output B]
A	[Audio output A]			
B	[Audio output B]			
<p><b>get audio out N1 name</b>↵</p> <p>Show the current name for the specified output's audio.</p> <p>Available values for <b>N1</b>:</p> <table> <tr> <td>A</td> <td>[Audio output A]</td> </tr> <tr> <td>B</td> <td>[Audio output B]</td> </tr> </table>	A	[Audio output A]	B	[Audio output B]
A	[Audio output A]			
B	[Audio output B]			

COMMAND
Description and Parameters
<p><b>set dante friendly name N1</b> ←</p> <p>Set this unit's Dante device friendly network name.</p> <p><b>N1</b> = {Dante Name} [ASCII, 31 characters max]</p> <p><i>Note: Dante device names must consist of standard alphanumeric characters, and cannot contain space or underscore “_” characters. The hyphen character “-” can be used, but not at the beginning or end of the name.</i></p>
<p><b>get dante friendly name</b> ←</p> <p>Show this unit's current Dante device friendly network name.</p>
<p><b>set dante rx N1 channel name N2</b> ←</p> <p>Set the name of the specified Dante audio Rx channel.</p> <p><b>N1</b> = 1~4 [Dante Rx channel number]</p> <p><b>N2</b> = {Channel Name} [ASCII, 31 characters max]</p>
<p><b>get dante rx N1 channel name</b> ←</p> <p>Show the current name of the specified Dante audio Rx channel.</p> <p><b>N1</b> = 1~4 [Dante Rx channel number]</p>
<p><b>set dante tx N1 channel name N2</b> ←</p> <p>Set the name of the specified Dante audio Tx channel.</p> <p><b>N1</b> = 1~4 [Dante Tx channel number]</p> <p><b>N2</b> = {Channel Name} [ASCII, 31 characters max]</p>
<p><b>get dante tx N1 channel name</b> ←</p> <p>Show the current name of the specified Dante audio Tx channel.</p> <p><b>N1</b> = 1~4 [Dante Tx channel number]</p>

## COMMAND

### Description and Parameters

#### **set dante rx N1 route N2@N3**↵

Route the specified remote Dante audio channel at the specified Dante device to the specified local Dante Rx channel.

**N1** = 1~4 [Local Dante Rx channel number]

**N2** = {Channel Name} [Remote Dante channel name]

**N3** = {Dante Name} [Remote Dante device friendly name]

#### **get dante rx N1 route**↵

Show the remote Dante device's channel that is currently routed to the specified local Dante Rx channel.

**N1** = 1~4 [Local Dante Rx channel number]

#### **set dante discover**↵

Trigger the discovery of all available Dante devices on the local network.

*Note: Only compatible Dante sources from the same manufacturer will be detected. Up to 4 additional Dante sources can be detected.*

#### **get dante N1 config**↵

Show the current Dante audio configuration of the specified Dante device.

Available values for **N1**:

1 [Local Dante device]

2~5 [Remote detected Dante devices (up to 4)]

*Note: Only compatible Dante sources from the same manufacturer will display results. Dante discovery must have been executed via WebGUI or console command before using this command.*



COMMAND	
Description and Parameters	
<b>set dante ip mode N1</b> ←	<p>Set the unit's IP address assignment mode for the Dante network port.</p> <p>Available values for <b>N1</b>:</p> <p>STATIC                    [Static IP mode]            DHCP                    [DHCP mode]</p>
<b>get dante ip mode</b> ←	<p>Show the current IP address assignment mode used by the Dante network port.</p>
<b>get dante ipconfig</b> ←	<p>Show the current IP configuration information for the Dante network port.</p>
<b>get dante ipaddr</b> ←	<p>Show the Dante network port's current IP address.</p>
<b>get dante netmask</b> ←	<p>Show the Dante network port's current netmask.</p>
<b>get dante gateway</b> ←	<p>Show the Dante network port's current gateway address.</p>
<b>set dante static ipaddr N1</b> ←	<p>Set the static IP address for the unit's Dante network port.</p> <p><b>N1</b> = X.X.X.X            [X = 0~255, IP address]</p>
<b>get dante static ipaddr</b> ←	<p>Show the current static IP address of the unit's Dante network port.</p>

COMMAND	
Description and Parameters	
<b>set dante static netmask N1</b> ↵	
Set the static netmask for the unit's Dante network port.	
<b>N1 = X.X.X.X</b>	[X = 0~255, Netmask]
<b>get dante static netmask</b> ↵	
Show the current static netmask of the unit's Dante network port.	
<b>set dante static gateway N1</b> ↵	
Set the static gateway address for the unit's Dante network port.	
<b>N1 = X.X.X.X</b>	[X = 0~255, Gateway address]
<b>get dante static gateway</b> ↵	
Show the current static gateway address of the unit's Dante network port.	
<b>set dante factory default N1</b> ↵	
Reset some or all of the unit's Dante settings to the factory defaults.	
Available values for <b>N1</b> :	
ALL	[Reset all Dante settings]
KEEP IP networking]	[Reset all Dante settings except networking]

*Note: Commands will not be executed unless followed by a carriage return. Commands are not case-sensitive.*

# 7. CONNECTION DIAGRAM

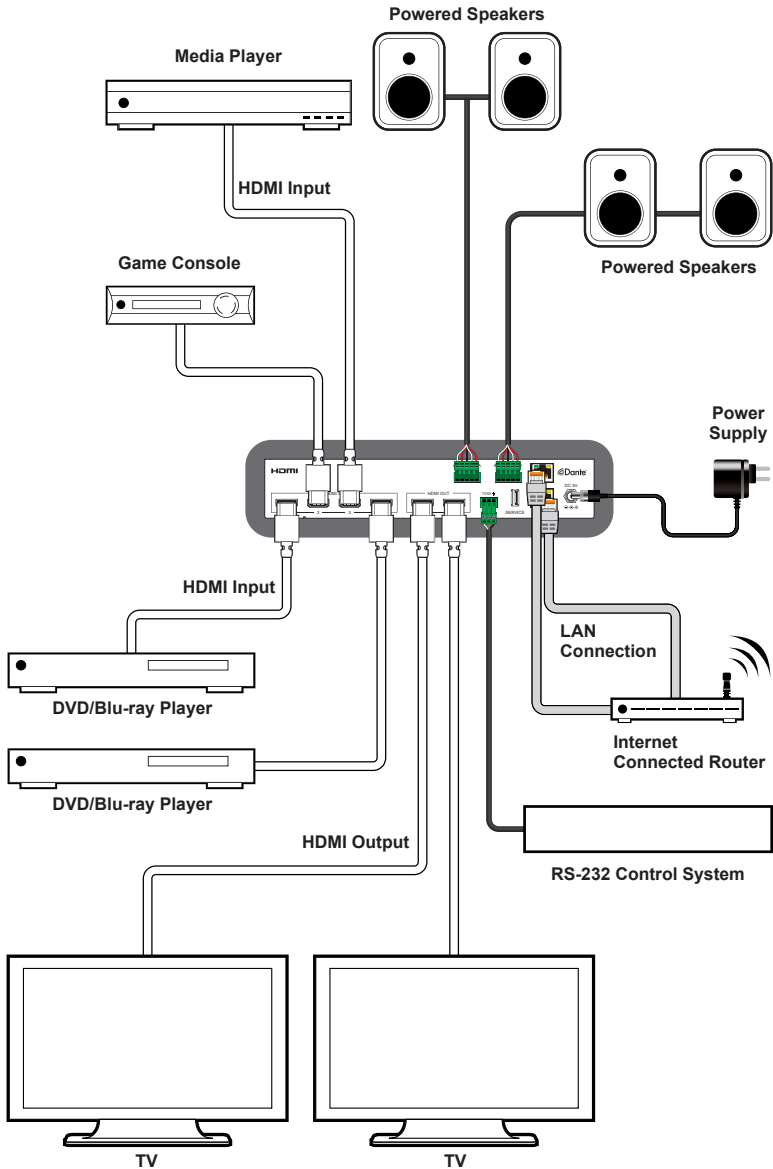

## 8. SPECIFICATIONS

### 8.1 Technical Specifications

<b>HDMI Bandwidth</b>	18Gbps
<b>Dante Bandwidth</b>	100Mbps
<b>Input Ports</b>	4×HDMI (Type-A)
<b>Output Ports</b>	2×HDMI (Type-A) 2×Stereo Audio (5-pin Terminal Block)
<b>Bi-directional Port</b>	1×Dante (RJ-45)
<b>Control Ports</b>	1×RS-232 (3-pin Terminal Block) 1×IP Control (RJ-45)
<b>Service Port</b>	1×USB 2.0 (Type-A)
<b>Baud Rate</b>	19200
<b>Power Supply</b>	5V/2.6A DC (US/EU standards, CE/FCC/UL certified)
<b>ESD Protection (HBM)</b>	±8kV (Air Discharge) ±4kV (Contact Discharge)
<b>Dimensions (W×H×D)</b>	240mm×43mm×104mm [Case Only] 240mm×48mm×112mm [All Inclusive]
<b>Weight</b>	807g
<b>Chassis Material</b>	Metal (Steel)
<b>Chassis Colour</b>	Black
<b>Operating Temperature</b>	0°C – 40°C/32°F – 104°F
<b>Storage Temperature</b>	-20°C – 60°C/-4°F – 140°F
<b>Relative Humidity</b>	20 – 90% RH (Non-condensing)
<b>Power Consumption</b>	11.68W

## 8.2 Video Specifications

Supported Resolutions (Hz)	Input	Output
	HDMI	HDMI
<b>720x400p@70/85</b>	✓	✓
<b>640x480p@60/72/75/85</b>	✓	✓
<b>720x480i@60</b>	✓	✓
<b>720x480p@60</b>	✓	✓
<b>720x576i@50</b>	✓	✓
<b>720x576p@50</b>	✓	✓
<b>800x600p@56/60/72/75/85</b>	✓	✓
<b>848x480p@60</b>	✓	✓
<b>1024x768p@60/70/75/85</b>	✓	✓
<b>1152x864p@75</b>	✓	✓
<b>1280x720p@50/60</b>	✓	✓
<b>1280x768p@60/75/85</b>	✓	✓
<b>1280x800p@60/75/85</b>	✓	✓
<b>1280x960p@60/85</b>	✓	✓
<b>1280x1024p@60/75/85</b>	✓	✓
<b>1360x768p@60</b>	✓	✓
<b>1366x768p@60</b>	✓	✓
<b>1400x1050p@60</b>	✓	✓
<b>1440x900p@60/75</b>	✓	✓
<b>1600x900p@60RB</b>	✓	✓
<b>1600x1200p@60</b>	✓	✓
<b>1680x1050p@60</b>	✓	✓
<b>1920x1080i@50/60</b>	✓	✓

Supported Resolutions (Hz)	Input	Output
	HDMI	HDMI
<b>1920×1080p@24/25/30</b>	✓	✓
<b>1920×1080p@50/60</b>	✓	✓
<b>1920×1200p@60RB</b>	✓	✓
<b>2560×1440p@60RB</b>	✓	✓
<b>2560×1600p@60RB</b>	✓	✓
<b>2048×1080p@24/25/30</b>	✓	✓
<b>2048×1080p@50/60</b>	✓	✓
<b>3840×2160p@24/25/30</b>	✓	✓
<b>3840×2160p@50/60 (4:2:0)</b>	✓	✓
<b>3840×2160p@24, HDR10</b>	✓	✓
<b>3840×2160p@50/60 (4:2:0), HDR10</b>	✓	✓
<b>3840×2160p@50/60</b>	✓	✓
<b>4096×2160p@24/25/30</b>	✓	✓
<b>4096×2160p@50/60 (4:2:0)</b>	✓	✓
<b>4096×2160p@24, HDR10</b>	✓	✓
<b>4096×2160p@50/60 (4:2:0), HDR10</b>	✓	✓
<b>4096×2160p@50/60</b>	✓	✓

## 8.3 Audio Specifications

### 8.3.1 Digital Audio

HDMI Input / Output	
LPCM	
<b>Max Channels</b>	8 Channels
<b>Sampling Rate (kHz)</b>	32, 44.1, 48, 88.2, 96, 176.4, 192
Bitstream	
<b>Supported Formats</b>	Standard & High-Definition
Dante Input	
LPCM	
<b>Max Channels</b>	4 Channels
<b>Sampling Rate (kHz)</b>	48
Bitstream	
<b>Supported Formats</b>	None
Dante Output	
LPCM	
<b>Max Channels</b>	4 Channels
<b>Sampling Rate (kHz)</b>	48
Bitstream	
<b>Supported Formats</b>	None

### 8.3.2 Analogue Audio

Analogue Output	
<b>Max Audio Level</b>	4.2Vrms
<b>THD+N</b>	< -80dB@0dBFS 1kHz (A-wt)
<b>SNR</b>	> 110dB@0dBFS
<b>Frequency Response</b>	< ±1dB@20Hz~20kHz
<b>Crosstalk</b>	< -88dB@10kHz
<b>Impedance</b>	499Ω
<b>Type</b>	Balanced



## 8.4 Cable Specifications

Cable Length	1080p		4K30	4K60
	8-bit	12-bit	(4:4:4) 8-bit	(4:4:4) 8-bit
<b>High Speed HDMI Cable</b>				
<b>HDMI Input</b>	15m	10m	5m	3m
<b>HDMI Output</b>	15m	10m	5m	3m
<b>Ethernet Cable (Dante Audio Only)</b>				
<b>Cat.5e/6</b>	100m			
<b>Cat.6A/7</b>	100m			

### Bandwidth Category Examples:

#### 1080p (FHD Video)

- Up to 1080p@60Hz, 12-bit colour
- Data rates lower than 5.3Gbps or below 225MHz TMDS clock

#### 4K30 (4K UHD Video)

- 4K@24/25/30Hz & 4K@50/60Hz (4:2:0), 8-bit colour
- Data rates higher than 5.3Gbps or above 225MHz TMDS clock but below 10.2Gbps

#### 4K60 (4K UHD<sup>+</sup> Video)

- 4K@50/60Hz (4:4:4, 8-bit)
- 4K@50/60Hz (4:2:0, 10-bit HDR)
- Data rates higher than 10.2Gbps

## 9. ACRONYMS

<b>ACRONYM</b>	<b>COMPLETE TERM</b>
<b>ASCII</b>	American Standard Code for Information Interchange
<b>Cat.5e</b>	Enhanced Category 5 cable
<b>Cat.6</b>	Category 6 cable
<b>Cat.6A</b>	Augmented Category 6 cable
<b>Cat.7</b>	Category 7 cable
<b>CLI</b>	Command-Line Interface
<b>DAC</b>	Digital-to-Analogue Converter
<b>dB</b>	Decibel
<b>DHCP</b>	Dynamic Host Configuration Protocol
<b>DVI</b>	Digital Visual Interface
<b>EDID</b>	Extended Display Identification Data
<b>GbE</b>	Gigabit Ethernet
<b>Gbps</b>	Gigabits per second
<b>GUI</b>	Graphical User Interface
<b>HDCP</b>	High-bandwidth Digital Content Protection
<b>HDMI</b>	High-Definition Multimedia Interface
<b>HDR</b>	High Dynamic Range
<b>IP</b>	Internet Protocol
<b>kHz</b>	Kilohertz
<b>LAN</b>	Local Area Network
<b>LED</b>	Light-Emitting Diode
<b>LPCM</b>	Linear Pulse-Code Modulation
<b>MHz</b>	Megahertz

ACRONYM	COMPLETE TERM
<b>SNR</b>	Signal-to-Noise Ratio
<b>TCP</b>	Transmission Control Protocol
<b>THD+N</b>	Total Harmonic Distortion plus Noise
<b>TMDS</b>	Transition-Minimised Differential Signaling
<b>4K UHD</b>	4K Ultra-High-Definition (10.2Gbps max)
<b>4K UHD<sup>+</sup></b>	4K Ultra-High-Definition (18Gbps max)
<b>USB</b>	Universal Serial Bus
<b>VGA</b>	Video Graphics Array
<b>WUXGA (RB)</b>	Widescreen Ultra Extended Graphics Array (Reduced Blanking)
<b>XGA</b>	Extended Graphics Array
<b>Ω</b>	Ohm



---

CYP (UK) Ltd., Unit 7, Shepperton Business Park, Govett Avenue,  
Shepperton, Middlesex, TW17 8BA

Tel: +44 (0) 20 3137 9180 | Fax: +44 (0) 20 3137 6279

Email: [sales@cypeurope.com](mailto:sales@cypeurope.com)

[www.cypeurope.com](http://www.cypeurope.com)

RDV1